

S 91

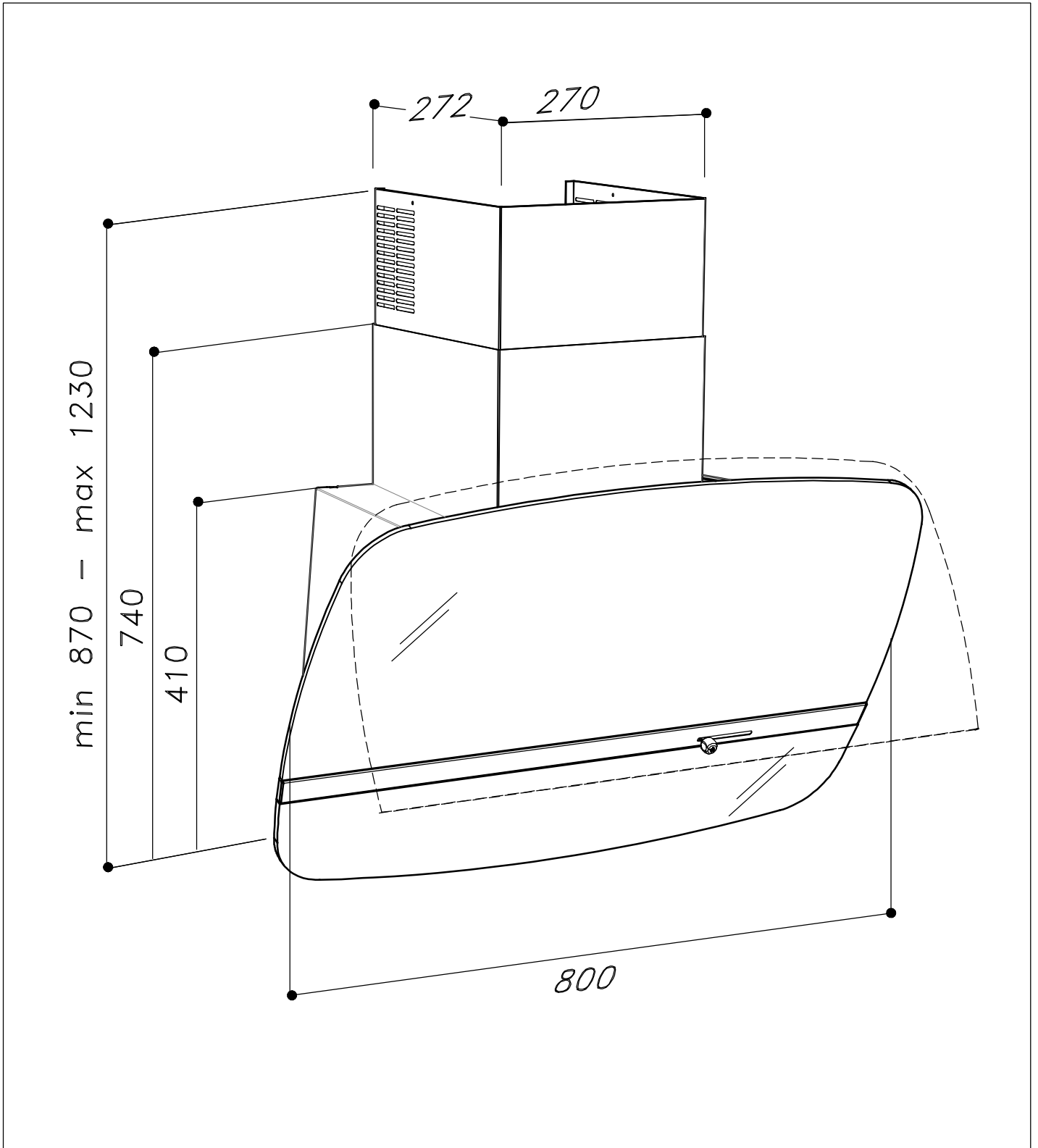

06/05/2013